

Buckingham Mfg Co.

Buck Hook™ System Instructions / Warnings

Read carefully, understand, and heed these and all included cautions, instructions and warnings before using this equipment. Failure to do so could result in your serious injury or death.

The Buck Hook™ is a safety device used to provide a temporary, portable anchorage point of a fall protection system to structure from ground to elevated heights back to ground. The system can be used in conjunction with a rope lifeline (7/16" min) and compatible rope grab or a retractable lanyard. The Buck Hook™ is to be connected to a standard fiberglass stick with universal head.

The configuration of the Buck Hook™ will fit around a 5 7/8" x 5 7/8" section of angle steel (see Fig. 1). When installed, the major axis position of the Buck Hook™ shall be aligned within + 45° from vertical.

Buckingham's Buck Hook™ System allows the user to ascend and descend the structure while remaining 100% fall protected.

To properly assemble the Buck Hook™ System requires either option 1 (Fig. 2) or option 2 (Fig. 16) components.

Note: Hardware and components, although BMC supplied is recommended, may differ from that shown in Fig. 2 and Fig. 16.

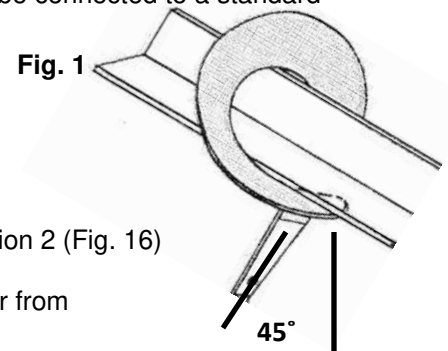

OPTION 1

- 1 – 50371U Buck Hook™
- 1 – 5004L Fall Arrester
- 1 – 39S2Q2-16 Lifeline
(with 16-200 attached)
- 1 – Fiberglass Pole
- 1 – 5005T Steel Carabiner



HOW TO ASSEMBLE THE BUCK HOOK™ SYSTEM OPTION 1

- A. Attach the 50371U to the end of the fiberglass pole (Fig. 3). The fiberglass pole shall hang vertically within +5 degrees when attached to the Buck Hook™ which is positioned over a section of angle steel.
- B. Attach the 39S2Q2-16 lifeline to the 50371U Buck Hook™ using the 5005T carabiner (Fig. 4)
- C. Attach the 5004L Fall Arrester to the lifeline (Fig. 5-9)



HOW TO ASCEND WITH THE BUCK HOOK™ SYSTEM USING OPTION 1

1. Extend Fiberglass pole all the way out.
2. Place Buck Hook™ over the lattice of the structure in a place suitable for anchorage. (Fig. 11 - 12). Note, bottom of fiberglass pole must remain below the user's feet to eliminate the possibility of the Buck Hook™ being inadvertently lifted off the anchorage point
3. Connect the 5004L fall arrester that is already attached to the lifeline to the sternal attachment of your harness using the attached carabiner (Fig. 13). Note only use the oval TRIACT Lock Carabiner provided with the fall arrester.
4. Climb structure until you reach the top of the lifeline (Fig. 14)

5. Secure your secondary positioning lanyard (not to exceed a 2' fall) around tower leg (Fig.15)
6. Once secure, reposition the Buck Hook™ to the next highest point ensuring the bottom of the fiberglass pole is below the feet at all times while ascending.
7. Disconnect secondary positioning lanyard.
8. Repeat steps 4 – 7 until desired height is reached

Note: In the event the fall arrester is impacted it will need to be unlocked. To unlock, remove weight from the fall arrester then press the locking wheel towards the rope and slide the fall arrester up the rope a few inches until you hear a click. The fall arrester is now unlocked (Fig. 10).



a. Depress silver button on side of locking wheel

b. Insert rope into channel of Fall Arrester

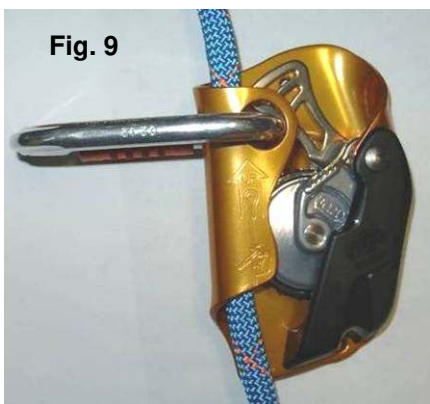

c. Attach carabiner to Fall Arrester

Unlocking

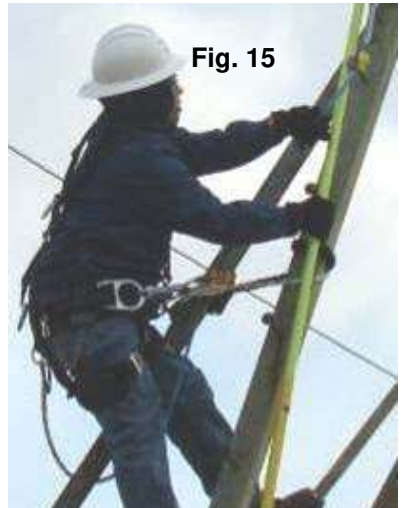

OPTION 2

- 1 – 50371U Buck Hook™
- 1 – 6007-164DV+Z Retractable Lanyard
- 1 – Fiberglass Pole



HOW TO ASSEMBLE THE BUCK HOOK™ SYSTEM OPTION 2

- A. Attach the 50371U to the end of the fiberglass pole (Fig. 17). The fiberglass pole shall hang vertically within +5 degrees when attached to the Buck Hook™ positioned over a section of angle steel.
- B. Attach the 6007-164DV+Z to the 50371U Buck Hook™ using the 50051 carabiner attached to the units swivel (Fig. 18 - 19)

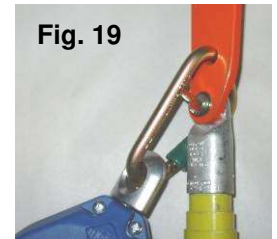
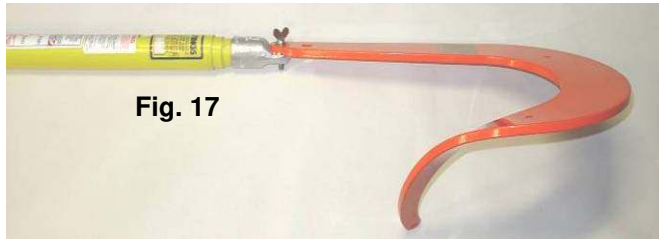

HOW TO ASCEND WITH THE BUCK HOOK™ SYSTEM USING OPTION 2

1. Extend Fiberglass pole all the way out.
2. Connect the locking snap hook of the retractable lanyard to either the dorsal (Fig.22) or sternal (Fig.23) attachment point of your harness.
3. Place the Buck Hook™ over the lattice of the structure in a place suitable for anchorage (2" angle and above) (Fig. 20-21).
4. Climb up the Step Bolts until you reach the Buck Hook™ (Fig. 24)
5. Secure secondary positioning lanyard (not to exceed a 2' fall) around tower leg (Fig.25) Once secure reposition Buck Hook™ to the next highest point
6. Disconnect secondary positioning lanyard.
7. Repeat steps 4 – 6 until the desired height is reached.





Note: When attaching the Buck Hook™ to a vertical member always attach as close to or around the vertical member as possible. If attaching to a horizontal member always attach as close to an intersection of two members as possible. Never attach in the middle of a long unsupported horizontal member.

WARNINGS

- Read understand and follow all instructions and warnings attached and/or packed with this product before use.
- This equipment is intended for use by properly trained professionals only.
- Fall protection equipment (i.e. fall arrest, work positioning belts, retrieval, suspension etc.) should not be resold or provided to others for re-use after use by original user as assurance cannot be granted that a used product meets criteria of applicable standards and is safe for use to a subsequent user.
- Anchor points must support a minimum of 5000 lbf. per attached worker and be independent of worker support.
- Harnesses equipped with a front-mounted attachment element for fall arrest shall be used only as part of a personal fall arrest system that limits the maximum free fall distance to two feet and limits the maximum arrest force to 900 pounds. Ensure the front attachment element is properly positioned as stated under “Donning Harness” in Buckingham’s Harness Wearing Instructions.
- Avoid rubbing of unit components against abrasive surfaces and sharp edges.
- Use this product only in combination with compatible equipment.
- Equipment subjected to impact loading must be immediately removed from service, destroyed and discarded.
- Always visually check that the snap hook / carabiner freely engages the anchor point and the keeper / gate is completely closed. Never rely on the feel or sound of a snap hook / carabiner engaging.
- Be certain the snap hook / carabiner is positioned so that its keeper / gate is never load bearing.
- Ensure loads applied to carabiners are directed in the proper orientation. Proper and improper loading techniques are shown below in Fig. 26
- Never disable the locking mechanism on the snap hook / carabiner, punch holes in or alter a connecting device or any part of this system in any way.
- Ensure there is no pressure on the snap hook locking mechanism sufficient to depress it as this will, due to its length, render it incompatible with currently designed D-rings and make it very susceptible to rollout.
- Do not let any part of this system come into contact with any chemicals, corrosive materials, acids or basic solvents.
- Wearing gloves while using this product is highly recommended.
- Product covered under these instructions / warnings should not be resold / redistributed or re-used after use by original user.
- Employer - instruct employees as to proper use, warnings and cautions before use of this equipment.

Proper Loading Techniques

Fig. 26

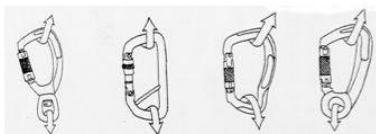

Improper Loading Techniques

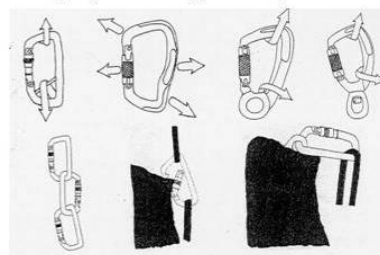

Maintenance

- Proper maintenance and storage of your equipment will prolong its useful life and contribute toward its performance. Clean equipment with water and mild soap and allow to dry thoroughly without using excessive heat. Lubricate as necessary.
- Apart from visual examination of product before and after each use, as a minimum, it should be inspected at least once a year by a competent person.
- Lubricate lock mechanism and keeper/gate on both sides of connector at least weekly or as often as required to maintain smooth operation (no binding) with light weight lubricant such as WD-40®

INSPECTION

Prior to and after each use, carefully inspect each component. It is also recommended all components be removed from the storage bag and as a minimum, be inspected every six months by a competent person. The inspection should include, but not be limited to the following:

Fall Arrester

- Inspect to ensure there are no cracks, distortion, nicks or burrs.
- Make sure the rope is woven through the arrester correctly as illustrated on the unit and shown in these instructions.
- Inspect for proper operation of device.

Note: Refer to these as well as the separately included manufacturers Instructions / Warnings for this device

Rope

- Inspect for cuts, kinks, abrasions burns, broken fibers, chemical or physical exposures, excessive wear, discoloration, swelling, or herniated rope (core popping through cover).
- Inspect stitched eye for excessive wear, abrasions, cut, broken, missing or unraveling thread or broken fibers.

Carabiners

- Ensure locking device and or keeper / gate operate freely and smoothly.
- Inspect to ensure there are no cracks, distortion, corrosion or nicks.

If any evidence of wear or deterioration as outlined is observed, immediately cease use, destroy the product, and replace it with new equipment. Should any unusual conditions not outlined above be observed or you have reasonable doubt about a particular condition, remove the equipment from service and notify your Supervisor, Safety Director, or contact Buckingham Mfg. Co. for clarification.

BUCKINGHAM MFG. CO.
BINGHAMTON, NY
www.buckinghammfg.com
1-800-937-2825

Information contained in these written instructions supersedes all other information (written, audio, video etc.) produced by Buckingham Mfg. prior to the revision date of this document.